

Silhouet

Twin Towel Rail 800 mm

Article no.: 4831500
Finish: Chrome
Series: Silhouet

EAN no.: 5708516138389

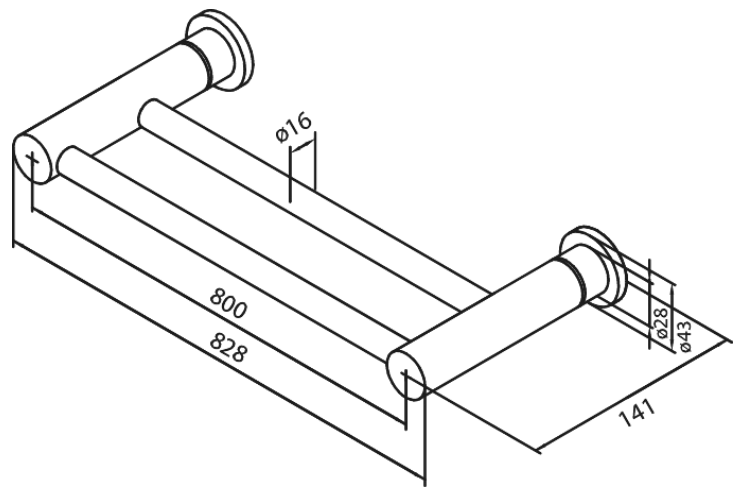

FM Mattsson Mora Group Denmark
Hvidkærvej 48, 5250 Odense SV, DK-56416218

+45 88 33 00 34 damixa-international@fmm-mora.com

Mere information på damixa.com

damixa